

2/2-way Solenoid Valve for fluids

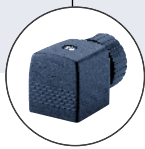

Type 6213 can be combined with...



Type 2508
Cable plug





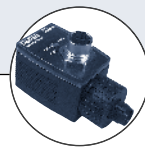

Type 1078
Timer unit



Type 2511
ASI cable plug



Type 8600
Dosing control

- Compact body from brass or stainless steel
- Push-over coil
- Waterhammer-free, low noise
- Diaphragm materials NBR, EPDM, FKM
- Approvals:     

The Type 6213 is a 2/2-way normally closed solenoid valve with a forced coupled diaphragm system. It switches from 1.5 PSI and can be used universally for fluids. For complete opening, a differential pressure of at least 1.5 PSI is necessary.

Power consumption

Orifice DN [mm]	Inrush		Hold	
	AC [VA]	DC [W]	AC [VA/W]	DC [W]
10	34	10	14/8	10
13	36	10	14/8	10
20	38	10	14/8	10
25	160	-	38/18	-
40	202	-	38/18	-

Technical data	
Orifice	DN 10 – 40 mm
Body material	Brass, stainless steel 1.4404 (316L)
Inner part of valve	Brass body Stainless steel body
Seal material	NBR, FKM, EPDM
Media	NBR FKM EPDM
	Neutral fluids, water, hydraulic oil, oil without additives Per-solutions, hot oils with additives Oil and fat-free fluids
Ambient temperature	Max. 131°F (+55°C)
Media temperature	NBR FKM EPDM
	14°F to 176°F (-10°C to +80°C) 32°F to 194°F (0°C to +90°C) -22°F to 248°F (-30°C to +120°C)
Voltage tolerance	±10%
Duty cycle	100% continuous rating
Electrical connection	Tag connector acc. to DIN 43650 Form A for cable plug Type 2508 (see Accessories)
Protection class	IP 65 with cable plug
Installation	As required, preferably with actuator upright

Dimensions [mm]

Dimensions [mm]											
G Thread			AC coil			DC coil			DC and AC coil		
DN	G	F	B	H	K	B	H	K	C	L (Brass/SS)	M
10	NPT 1/4	12	82.0	32	45	82.5	40	51	37.5	50/55	3.5
	NPT 3/8	12									
	NPT 1/2	14									
13	NPT 1/2	14	95.5	32	45	96.0	40	51	45.0	58/65	3.5
	NPT 3/4	16									
20	NPT 3/4	16	115.5	32	45	116.0	40	51	66.0	80/100	3.5
	NPT 1	18									
25	NPT 1	18	158.5	49	53	158.5	49	53	104.5	95/-	7.0
	NPT 1 1/4	20	163.0			163.0					
40	NPT 1 1/2	22	179.5	49	53	179.5	49	53	104.5	132/-	7.0
	NPT 2	24	184.5			184.5					

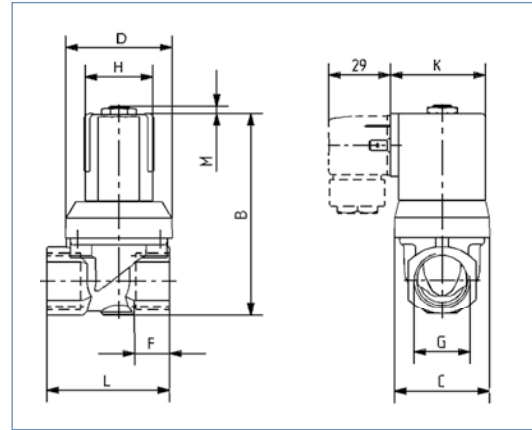

Specifications - Ordering chart (other versions on request)

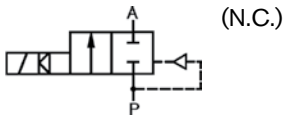

Brass Body, NBR Seal

U.L. Listed with 1/2" conduit plug Type 2509 0-250 V AC/DC

Port Connections [NPT]	Orifice [inch]	C _v	Pressure range [PSI]	Weight [lbs.]	Item no.			
					Voltage / Frequency			
					24/DC	24/60	120/60	240/60
3/8	3/8	2.4	1.5 - 145	0.9	456 534 J	456 535 K	456 536 L	456 537 M
1/2	3/8	2.4	1.5 - 145	1.2	456 546 W	456 547 X	456 548 G	456 549 H
1/2	1/2	4.2	1.5 - 145	1.2	456 538 W	456 539 X	456 540 C	456 541 Z
3/4	1/2	4.2	1.5 - 145	2.2	456 550 E	456 551 T	456 552 U	456 553 V
3/4	3/4	10.5	1.5 - 145	2.2	456 542 S	456 543 T	456 544 U	456 545 V
1	3/4	10.5	1.5 - 145	3.7	456 554 W	456 555 X	456 556 Y	456 557 Z
1	1	12.9	1.5 - 145	3.7	-	457 339 F	457 340 L	457 341 H
1 1/4	1	12.9	1.5 - 145	3.7	-	457 342 A	457 343 B	457 344 C
1 1/2	1 1/2	35.1	1.5 - 145	7.9	-	457 345 D	457 346 E	457 347 F
2	1 1/2	35.1	1.5 - 145	7.9	-	457 348 Q	457 349 R	457 350 N

Brass Body, FKM Seal

Port Connections [NPT]	Orifice [inch]	C _v	Pressure range [PSI]	Weight [lbs.]	Item no.			
					Voltage / Frequency			
					24/DC	24/60	120/60	240/60
3/8	3/8	2.4	1.5 - 145	0.9	456 558 A	456 559 B	456 560 G	456 561 V
1/2	1/2	4.2	1.5 - 145	1.2	456 562 W	456 563 Y	456 564 Y	456 565 Z
3/4	3/4	10.5	1.5 - 145	2.2	456 566 S	456 567 T	456 568 C	456 569 D

Stainless Steel Body, FKM Seal

Port Connections [NPT]	Orifice [inch]	C _v	Pressure range [PSI]	Weight [lbs.]	Item no.			
					Voltage / Frequency			
					24/DC	24/60	120/60	240/60
1/4	3/8	2.4	1.5 - 145	0.9	458 796 B	458 797 C	458 798 M	458 799 N
3/8	3/8	2.4	1.5 - 145	0.9	458 800 L	458 801 H	458 802 A	458 803 B
1/2	1/2	4.2	1.5 - 145	1.2	458 804 C	458 805 D	458 806 E	458 807 F
3/4	3/4	10.5	1.5 - 145	2.2	458 808 Q	458 809 R	458 810 D	458 811 S
1	3/4	10.5	1.5 - 145	3.7	458 812 T	458 813 U	458 814 V	458 815 W

Specifications – Ordering chart (other versions on request) (continued)

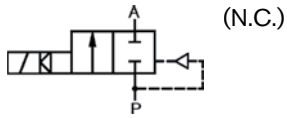

U.L. Recognized 
with standard-cable plug, Type 2508
0–250 V AC/DC

Brass Body, NBR Seal

Port Connections [NPT]	Orifice [inch]	C _v	Pressure range [PSI]	Weight [lbs.]	Item no. Voltage / Frequency			
					24/DC	24/60	120/60	240/60
1/4	3/8	2.4	1.5 – 145	0.9	458 078 N	458 079 P	458 080 D	458 081 S
3/8	3/8	2.4	1.5 – 145	0.9	456 439 T	456 440 G	456 441 V	456 442 W
1/2	3/8	2.4	1.5 – 145	1.2	456 449 D	456 450 A	456 451 X	456 452 Y
1/2	1/2	4.2	1.5 – 145	1.2	458 443 X	456 444 Y	456 300 L	456 445 Z
3/4	1/2	4.2	1.5 – 145	2.2	456 453 Z	456 454 S	456 455 T	456 456 U
3/4	3/4	10.5	1.5 – 145	2.2	456 446 S	456 447 T	456 301 H	456 448 C
1	3/4	10.5	1.5 – 145	3.7	456 457 Y	456 458 E	456 302 A	456 659 F
1	1	12.9	1.5 – 145	3.7	–	457 163 X	457 164 Y	457 165 Z
1 1/4	1	12.9	1.5 – 145	3.7	–	457 166 S	457 167 T	457 168 C
1 1/2	1 1/2	35.1	1.5 – 145	7.9	–	457 169 D	457 170 A	457 171 X
2	1 1/2	35.1	1.5 – 145	7.9	–	457 172 Y	457 173 Z	457 174 S

Brass Body, FKM Seal

Port Connections [NPT]	Orifice [inch]	C _v	Pressure range [PSI]	Weight [lbs.]	Item no. Voltage / Frequency			
					24/DC	24/60	120/60	240/60
1/4	3/8	2.4	1.5 – 145	0.9	458 082 T	458 083 U	458 084 V	458 085 W
3/8	3/8	2.4	1.5 – 145	0.9	456 460 C	456 461 Z	456 462 S	456 463 T
1/2	1/2	4.2	1.5 – 145	1.2	456 464 U	456 465 V	456 466 W	456 467 X
3/4	3/4	10.5	1.5 – 145	2.2	456 468 G	456 469 H	456 470 E	456 471 T

Stainless Steel Body, FKM Seal

Port Connections [NPT]	Orifice [inch]	C _v	Pressure range [PSI]	Weight [lbs.]	Item no. Voltage / Frequency			
					24/DC	24/60	120/60	240/60
1/4	3/8	2.4	1.5 – 145	0.9	458 732 A	458 733 B	458 734 C	458 735 D
3/8	3/8	2.4	1.5 – 145	0.9	458 736 E	458 737 F	458 738 Q	458 739 R
1/2	1/2	4.2	1.5 – 145	1.2	458 740 W	458 741 K	458 742 L	458 743 M
3/4	3/4	10.5	1.5 – 145	2.2	458 744 W	458 745 P	458 746 Q	458 747 R
1	3/4	10.5	1.5 – 145	3.7	458 748 S	458 749 T	458 750 Y	458 751 M

Specifications - Ordering chart (other versions on request)

U.L. Listed with 1/2" conduit plug Type 2509
0-250 V AC/DC

Brass Body, EPDM Seal

Port Connections [NPT]	Orifice [inch]	C _v	Pressure range [PSI]	Weight [lbs.]	Item no. Voltage / Frequency			
					24/DC	24/60	120/60	240/60
3/8	3/8	2.4	1.5 - 145	0.9	457 187 Q	457 188 Z	457 189 S	457 190 X
1/2	1/2	2.4	1.5 - 145	1.2	457 191 L	457 192 M	457 193 N	457 194 P
3/4	3/4	10.5	1.5 - 145	2.2	457 195 Q	457 196 R	457 197 J	457 198 T
1	1	12.9	1.5 - 145	3.7	-	457 351 B	457 352 C	457 353 D
1 1/4	1	12.9	1.5 - 145	3.7	-	457 354 E	457 355 F	457 356 G
1 1/2	1 1/2	35.1	1.5 - 145	7.9	-	457 357 N	457 358 J	457 359 K
2	1 1/2	35.1	1.5 - 145	7.9	-	457 360 Q	457 361 D	457 362 E

Stainless Steel Body, EPDM Seal

Port Connections [NPT]	Orifice [inch]	C _v	Pressure range [PSI]	Weight [lbs.]	Item no. Voltage / Frequency			
					24/DC	24/60	120/60	240/60
1/4	3/8	2.4	1.5 - 145	0.9	458 776 N	458 777 P	458 778 Y	458 779 Z
3/8	3/8	2.4	1.5 - 145	0.9	458 780 P	458 781 C	458 782 D	458 783 E
1/2	1/2	4.2	1.5 - 145	1.2	458 784 F	458 785 G	458 786 H	458 787 A
3/4	3/4	10.5	1.5 - 145	2.2	458 788 K	458 789 L	458 790 R	458 791 E
1	3/4	10.5	1.5 - 145	3.7	458 792 F	458 792 G	458 794 H	458 795 A

U.L. Recognized with standard-cable plug, Type 2508
0-250 V AC/DC

Brass Body, NBR Seal

Port Connections [NPT]	Orifice [inch]	C _v	Pressure range [PSI]	Weight [lbs.]	Item no. Voltage / Frequency			
					24/DC	24/60	120/60	240/60
1/4	3/8	2.4	1.5 - 145	0.9	458 086 X	458 087 Y	458 088 H	458 089 A
3/8	3/8	2.4	1.5 - 145	0.9	457 175 T	457 176 U	457 177 V	457 178 E
1/2	1/2	4.2	1.5 - 145	1.2	457 179 F	457 180 V	457 181 J	457 182 K
3/4	3/4	10.5	1.5 - 145	2.2	457 183 L	457 184 M	457 185 N	457 186 P
1	1	12.9	1.5 - 145	3.7	457 984 P	457 234 W	457 235 X	457 236 Y
1 1/4	1	12.9	1.5 - 145	3.7	457 985 Q	457 237 Z	457 238 A	457 239 B
1 1/2	1 1/2	35.1	1.5 - 145	7.9	457 986 R	457 240 Q	457 241 D	457 242 E
2	1 1/2	35.1	1.5 - 145	7.9	457 987 J	457 243 F	457 244 G	457 245 H

U.L. Recognized with Type 2511 plug for UC coil
0-250 V AC/DC

Brass Body, FKM Seal

Port Connections [NPT]	Orifice [inch]	C _v	Pressure range [PSI]	Weight [lbs.]	Item no. Voltage / Frequency			
					24/DC	24/60	120/60	240/60
1/4	3/8	2.4	1.5 - 145	0.9	458 712 E	458 713 F	458 714 G	458 715 H
3/8	3/8	2.4	1.5 - 145	0.9	458 716 A	458 717 B	458 718 L	458 719 M
1/2	1/2	4.2	1.5 - 145	1.2	458 720 J	458 721 F	458 722 G	458 723 H
3/4	3/4	10.5	1.5 - 145	2.2	458 724 A	458 725 B	458 726 C	458 727 D
1	3/4	10.5	1.5 - 145	3.7	458 728 N	458 729 P	458 730 L	458 731 H

Stainless Steel Body, EPDM Seal

Port Connections [NPT]	Orifice [inch]	C _v	Pressure range [PSI]	Weight [lbs.]	Item no. Voltage / Frequency			
					24/DC	24/60	120/60	240/60
1/2	1/2	4.2	1.5 - 145	1.2	458 752 N	458 753 P	458 754 Q	458 755 R
3/4	3/4	10.5	1.5 - 145	2.2	458 756 J	458 757 K	458 758 U	458 759 V
1	3/4	10.5	1.5 - 145	3.7	458 760 S	458 761 P	458 762 Q	458 763 R

In case of special application conditions,
please consult for advice.We reserve the right to make technical
changes without notice.

0602/2_US-en